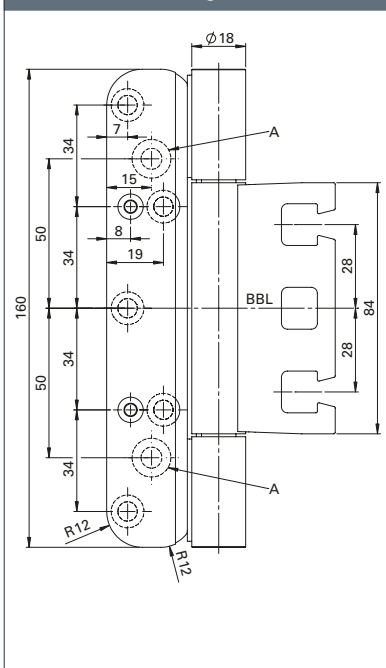

OBX-18-1532/160-FD-RC-B

Performance criteria

Size		160 mm
Ø knuckle		18 mm
Material thickness		3 mm
Screw cover bracket		Ø 3.5 x 25 mm
Screw hinge		Ø5 x 50 mm
DIN-L / DIN-R		Yes
Mill diameter		24 mm
Milling length		160 mm
Milling depth		10.5 mm
Door types	Rebate	Yes
	Flush	-
Frame types	Wooden	Yes
	Steel	Yes
	Aluminium	Yes
Suitable for fire doors	F	Yes
Load-bearing class 14 (door weight)	EN 1935 CE	Yes
	according to standard	160 kg
	ECO load-bearing capacity	200 kg
Material	Stainless steel (ER)	Yes
Finishes	ER matt brushed	Yes
	ER polished	■
	PVD coating	■
	Powder coating in RAL shades	■
Frame boxes	Block frame	OBX-3101-3D
	Casing frame	OBX-3102-3D
		OBX-3106-3D
	Masking frame	OBX-3105-3D
	Steel frame	OBX-3011-3D
		OBX-3012-3D
	Aluminium frame	OBX-3121-3D

■ Yes - No ■ On request

Dimensional drawing standard / (TZ)

Cross-section with load-bearing stud (TZ)



Technical drawing showing the cross-section of the hinge with a load-bearing stud. Key dimensions include: total width 39 mm, stud diameter Ø12 mm, and mounting hole offset 37.5 mm. The drawing shows the hinge's internal structure, including the mounting bracket and the stud.

Cross-section with secure stud (SI)



Technical drawing showing the cross-section of the hinge with a secure stud. Key dimensions include: total width 39 mm, stud diameter Ø12.5 mm, and mounting hole offset 37.5 mm. The drawing shows the hinge's internal structure, including the mounting bracket and the stud.

A: Only for design with load-bearing stud. ■ Frame box 3D series OBX is sold separately. Load-bearing studs/screws must be ordered separately.

Hinge with RC-B hole pattern

Standard



OBX-18-1532/160-FD-RC-B

With load-bearing stud (TZ)

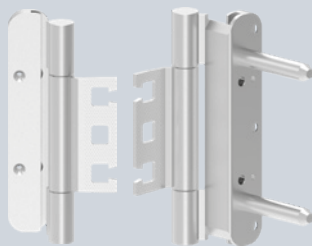

OBX-18-1532/160-FD-RC-B TZ

With secure stud (SI)

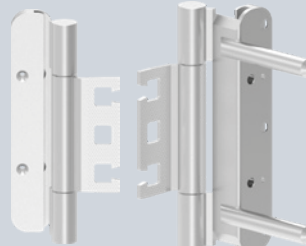

OBX-18-1532/160-FD-RC-B SI

Description

ECO Horizon object hinge OBX-18-1532/160-FD-RC-B

- For rebated soundproof doors on wooden, steel or aluminium frames
- For OBX frame boxes adjustable in three dimensions
- Concealed, permanently mounted rotating axis, so no pin fixation required

- Wear- and maintenance-free ball bearing technology for absorbing radial and axial forces
- Perfectly closed hinge knuckle without cover head
- Suitable for burglar-resistant elements
- Suitable for use on FH doors
- DIN left/DIN right, can be used without conversion work
- EN 1935: Class 14 / 160 kg

Cross-section standard

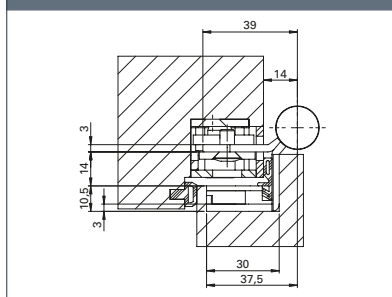

F **EN 1935** **CE** **ER**  Wooden door

OBX-18-1532/160-FD-RC-B For rebated doors	Dimensions	Art. no.
OBX-18-1532/160-FD-RC-B ER	Ø 18 x 160 mm	5030054208
OBX-18-1532/160-FD-RC-B TZ ER	Ø 18 x 160 mm	5030055295
OBX-18-1532/160-FD-RC-B SI ER	Ø 18 x 160 mm	5030054214

Milling pattern standard

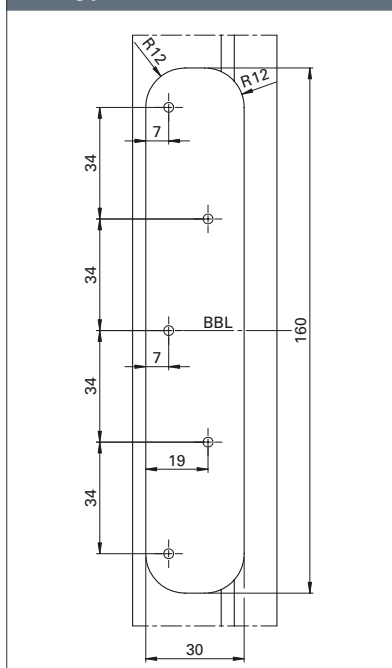

Milling pattern load-bearing stud (TZ)

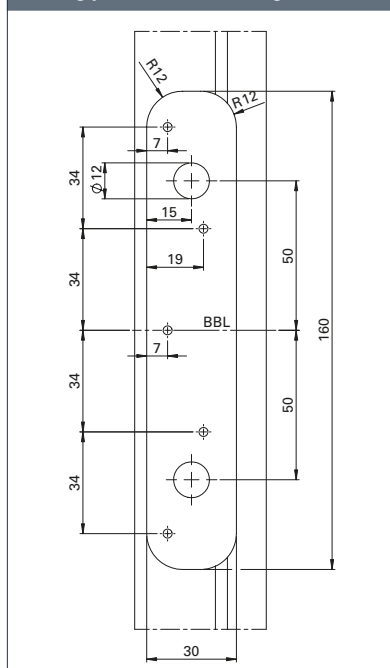

Milling pattern secure stud (SI)

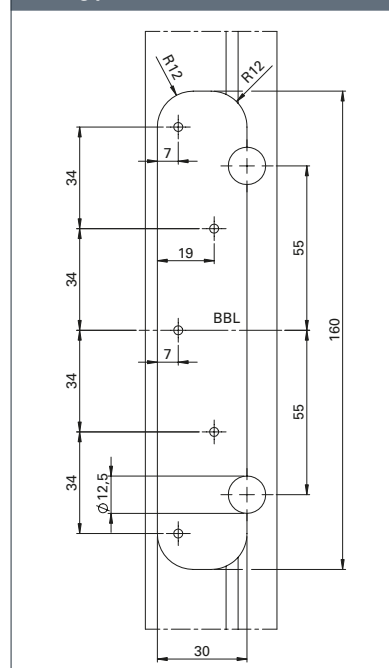

ECO Schulte GmbH & Co. KG

Iserlohner Landstraße 89

D-58706 Menden

Telephone +49 2373 9276 - 0

Telefax +49 2373 9276 - 40

info@eco-schulte.de

www.eco-schulte.de

Our compendium represents a compilation of all products from our range of services. These are subject to different delivery classes. Special variants included are often manufactured to customer specifications and sometimes require longer delivery times and minimum purchase quantities. Further advise can be given by your contact person.

■ SYSTEM TECHNOLOGY FOR THE DOOR

