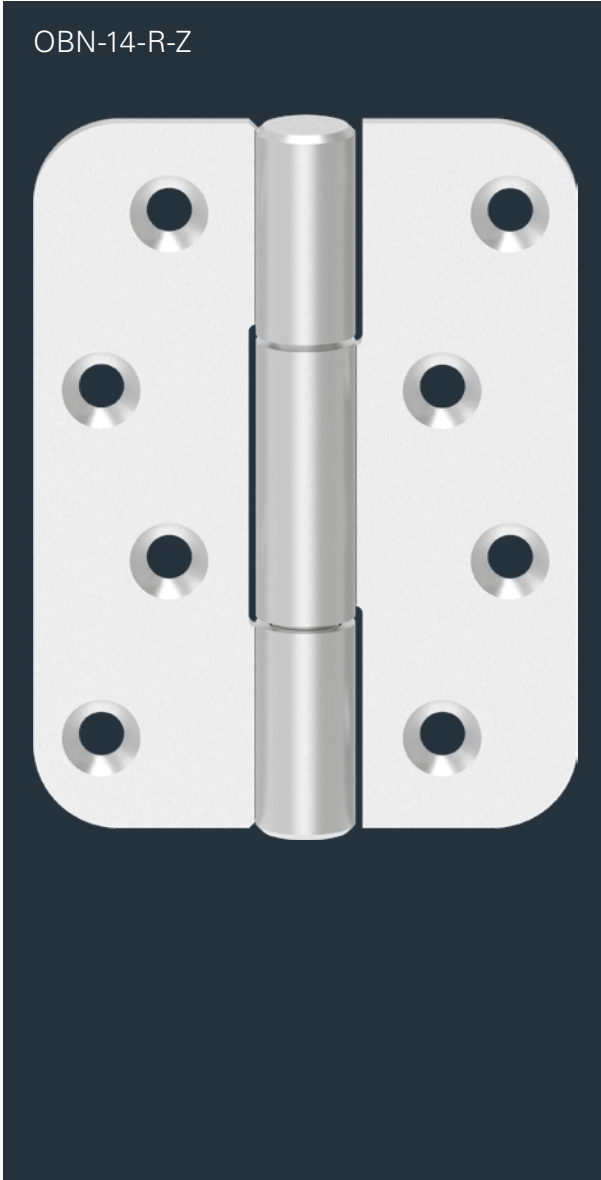
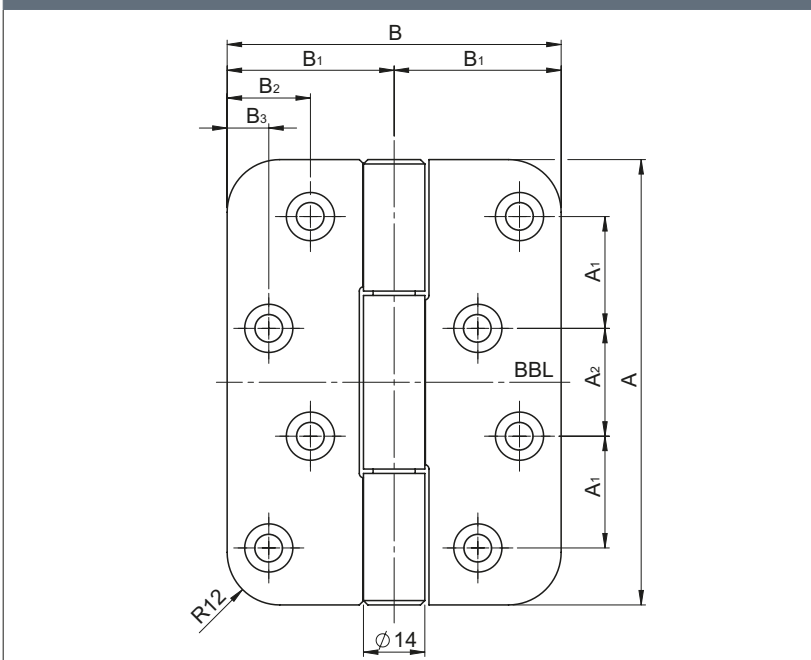
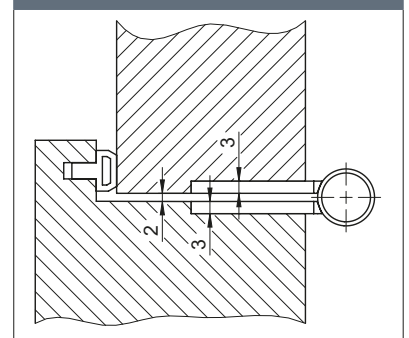

OBN-14-R-Z

Performance criteria

Ø knuckle		14 mm
Material thickness		3 mm
Screws		Ø 5 x 30
DIN-L / DIN-R		Yes
Mill diameter		24 mm
Hole pattern	C-shape	-
	Z-shape	Yes
Door types	Rebate	-
	Flush	Yes
Frame types	Wooden	Yes
	Steel	-
Suitable for fire doors	F	Yes
Load-bearing class 14	EN 1935 CE	Yes
Door weight	according to standard	160 kg
Material	Stainless steel (ER)	Yes
Finishes	ER matt brushed	Yes
	ER polished	-
	PVD coating	■
	Powder coating in RAL shades	■

■ Yes - No ■ On request

Dimensional drawing

Cross-section

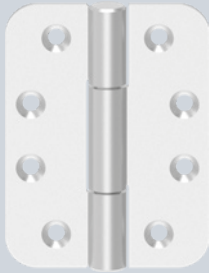

ECO

Object hinges Horizon ■ OBN-14 ■ For flush doors ■ Round ■ Z hole pattern**PRODUCT FAMILY ■ FOR FLUSH DOORS**

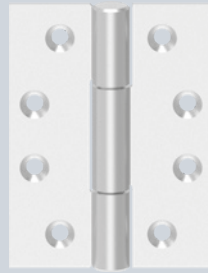
OBN-14-R-C round C hole pattern



OBN-14-E-C rectangular C hole pattern

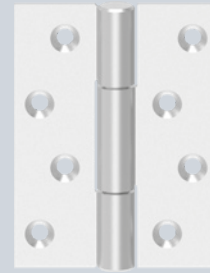

OBN-14-E-Z rectangular Z hole pattern

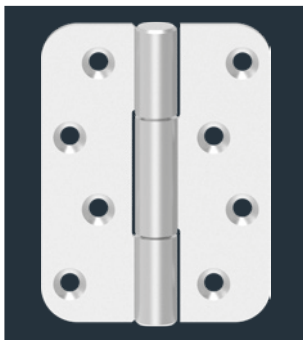
**Description****ECO Horizon object hinge OBN-14-R-Z round Z hole pattern**

- For flush doors on wooden frames
- Concealed, fixed axis
- Patented wear- and maintenance-free ball bearing technology for absorbing radial and axial forces
- Suitable for use on FS doors
- DIN left/DIN right, can be used without conversion work
- Invisible axle connection (without cover head)

F **EN 1935** **CE** **ER**  Wooden door

OBN-14-R-Z round Z hole pattern For flush doors	Dimensions A x B inch	Dimensions A x B inch	A ¹ mm	A ² mm	B ¹ mm	B ² mm	B ³ mm	Art. no.
OBN-14-4030-R-Z.ER	4 x 3 inch	101.6 x 76.2 mm	25.5 mm	24.6 mm	38.1 mm	19 mm	9.5 mm	5030047534
OBN-14-4035-R-Z.ER	4 x 3.5 inch	101.6 x 88.9 mm	25.5 mm	24.6 mm	44.45 mm	19 mm	9.5 mm	5030047535
OBN-14-4040-R-Z.ER	4 x 4 inch	101.6 x 101.6 mm	25.5 mm	24.6 mm	50.8 mm	19 mm	9.5 mm	5030047536
OBN-14-4540-R-Z.ER	4.5 x 4 inch	114.3 x 101.6 mm	28.6 mm	31.3 mm	50.8 mm	25.4 mm	9.5 mm	5030048012
OBN-14-5030-R-Z.ER	5 x 3 inch	127 x 76.2 mm	31.75 mm	37.7 mm	38.1 mm	19 mm	9.5 mm	5030048016
OBN-14-5035-R-Z.ER	5 x 3.5 inch	127 x 88.9 mm	31.75 mm	37.7 mm	44.45 mm	25.4 mm	9.5 mm	On request
OBN-14-5040-R-Z.ER	5 x 4 inch	127 x 101.6 mm	31.75 mm	37.7 mm	50.8 mm	25.4 mm	9.5 mm	5030048020
OBN-14-5050-R-Z.ER	5 x 5 inch	127 x 127 mm	31.75 mm	37.7 mm	63.5 mm	25.4 mm	9.5 mm	5030048024

ECO Schulte GmbH & Co. KG

Iserlohner Landstraße 89

D-58706 Menden

Telephone +49 2373 9276 - 0

Telefax +49 2373 9276 - 40

info@eco-schulte.de

www.eco-schulte.de

Our compendium represents a compilation of all products from our range of services. These are subject to different delivery classes. Special variants included are often manufactured to customer specifications and sometimes require longer delivery times and minimum purchase quantities. Further advise can be given by your contact person.

■ SYSTEM TECHNOLOGY FOR THE DOOR

