

**Performance criteria**

Tested according to	<b>EN 1906</b>
with 9 mm square spindle fire protection tested according to DIN 18273	<b>F</b>
Lever handle shape suitable for emergency exits and fire barrier doors	<b>EN 179</b>
Return spring with 90° stop	■
Fixed sleeve nuts / supporting cams	■
Fixed swivel-mounted lever handle	■
Grooved ball bearing with flexible/compensating bearing	■
Steel substructure with nylon clip ring	■
Concealed, continuous screw attachment	■
DIN L / R	■
EN 1906 – corrosion class 5	■
1 million test cycles (MPAZert)	■

Classification key EN 1906

4	D9	-	B1	1	5	0	B/U
---	----	---	----	---	---	---	-----

■ Yes –No □ Optional



Steel door



Wooden door

Material:

**ER** ER  
Stainless steel

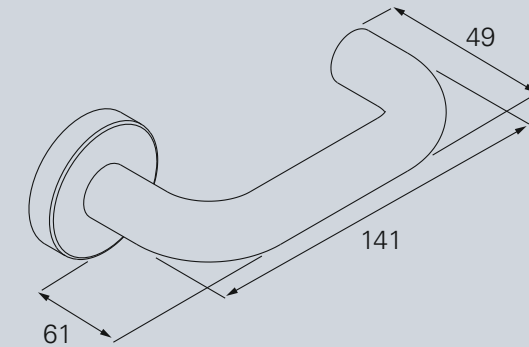

**OKL Magis**

Material:

**ER** ER  
Stainless steel

**Al** Al  
Aluminium

**Ku** Ku  
Nylon

Bearing technology:

**OKL Magis**

**OGI Click**

**OGI**

**SGL Click**

**PRODUCT FAMILY D-100**

**Standard fitting**



D-110



D-120



D-190



D-110 .



D-110 .

**Handle on oval rose**

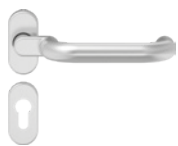

D-115 .



D-116 .

**Security handle**



D-110 .



D-111



D-116 .

**Window handle**



FO-110 .

# D-110 round rose

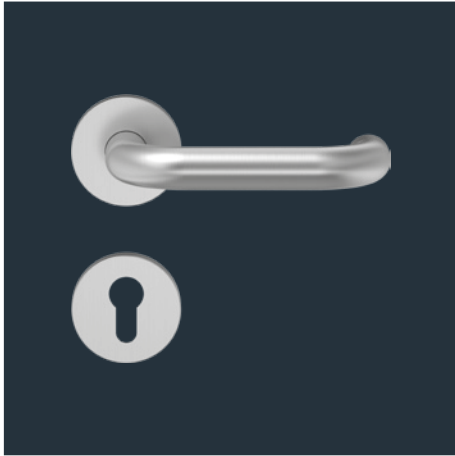

## D-110 round rose with OKL Magis – ball-bearing technology

Object fitting with a maintenance-free closed ball bearing and integrated flexible bearing for lever handle guidance. Fixed substructure with spring reset and a 90° fixed stop. Steel substructure with positioning studs and integrated fixing bolts. Concealed, continuous screw attachment, cover roses in an angular design. For knob/lever fittings, please note the DIN direction.

User category class 4, corrosion class 5, supporting cams  $\varnothing 8 \times 5$  mm

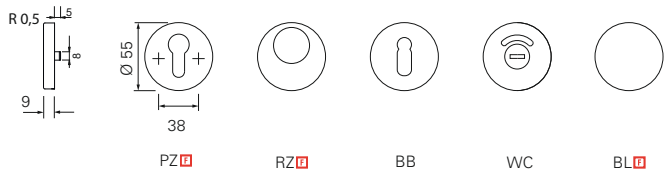

The measurements for our knobs can be found on page 407

### OKL MAGIS – HANDLE ON ROUND ROSE

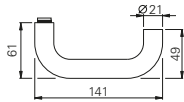

				Fittings set							
	$\varnothing$	$\nabla$		PZ	RZ	BB	WC-SK	K-135	K-165	K-160	K-116
	21 mm	8 mm		173005.46 97	173025.46 97	173000.46 97	173020.46 97				
Can be used for DIN L/R											
	(1) DIN R knob hinge side							173011.46 97	173031.46 97	173041.46 97	173081.46 97
	(2) DIN L knob Opposite hinge side							173011.46 97	173031.46 97	173041.46 97	173081.46 97
	(3) DIN L knob hinge side							173010.46 97	173030.46 97	173040.46 97	173080.46 97
	(4) DIN R knob Opposite hinge side							173010.46 97	173030.46 97	173040.46 97	173080.46 97
	$\varnothing$	$\nabla$		PZ	RZ	BB	WC-SK	K-135	K-165	K-160	K-116
	21 mm	9 mm		373005.46 74	373025.46 74						
Can be used for DIN L/R											
	(1) DIN R knob hinge side							373011.46 74	373031.46 74	373041.46 74	373081.46 74
	(2) DIN L knob Opposite hinge side							373011.46 74	373031.46 74	373041.46 74	373081.46 74
	(3) DIN L knob hinge side							373010.46 74	373030.46 74	373040.46 74	373080.46 74
	(4) DIN R knob Opposite hinge side							373010.46 74	373030.46 74	373040.46 74	373080.46 74

Finish: matt brushed. PVD and polished on request

Panic model with passive leaf (with supporting cams), passive leaf (without supporting cams) and UG models available on request.

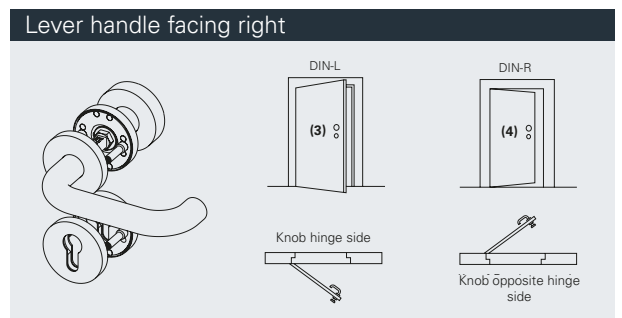
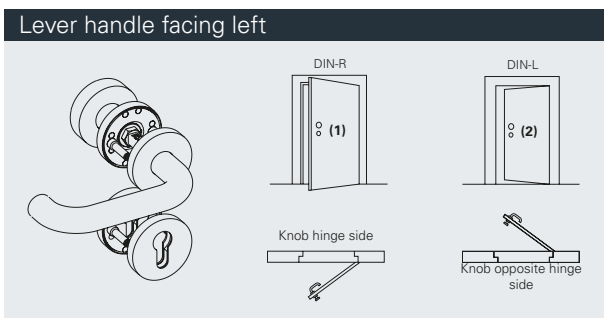

Standard fitting for door thicknesses: 38–45 mm. Door thicknesses for fire doors: 44–66 mm. Fittings for other door thicknesses available on request.

# D-110 round rose



### D-110 round rose with OGI Click – friction bearing technology

Maintenance-free lever handle guidance integrated into a steel/nylon base rose as a friction bearing. Spring assistance. Fixed swivel-mounted lever handle with ECO Click system for quick and easy installation. Steel substructure with positioning studs and integrated fixing bolts. Can be used for DIN left/DIN right. Concealed, continuous M5 screw attachment.

User category class 4. Supporting cams  $\varnothing 8 \times 5$  mm. Available with and without supporting cams

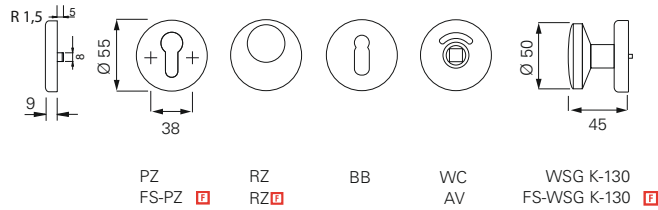

## OGI CLICK – HANDLE ON ROUND ROSE

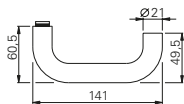

**F** = 4 7 - B1 1 4 0 A

			Fittings set						Passive leaf fittings set	
	$\varnothing$	$\nabla$								
	21 mm	8 mm		5030048149	5030048169	5030048150	5030048162	5030048164	5030048168	
	21 mm	9 mm		5030048171	5030048170		5030048177		5030048182	5030048184 5030048183
	21 mm	9 mm								

Finish: matt brushed. PVD and polished on request

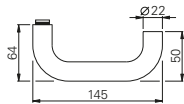

**F** = 4 7 - D1 1 4 0 A

			Fittings set						Passive leaf fittings set	
	$\varnothing$	$\nabla$								
	22 mm	8 mm		5030048163	5030048188	5030048205	5030048197	5030049254	5030048178	
	22 mm	9 mm		5030049271	5030049285		5030049305		5030049434	5030049435 5030049436
	22 mm	9 mm								

Finish: F1 anodised aluminium; further colours available on request.

# D-110 round rose

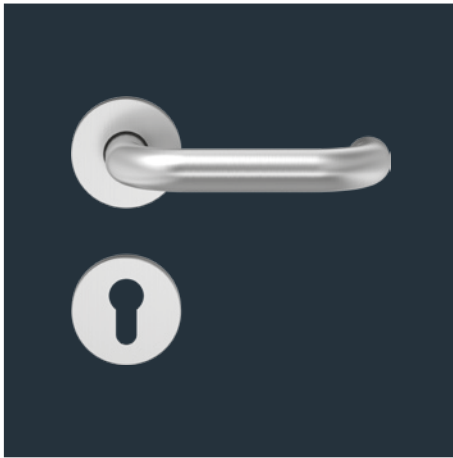

### D-110 round rose with OGL – friction bearing technology

Lever handle guidance with a maintenance-free friction bearing made of self-lubricating nylon. Fixed swivel-mounted lever handle. Can be used for DIN left/DIN right. Steel substructure with positioning studs. Non-visible, continuous screw attachment.

User category class 4, supporting cams Ø 8 x 5 mm

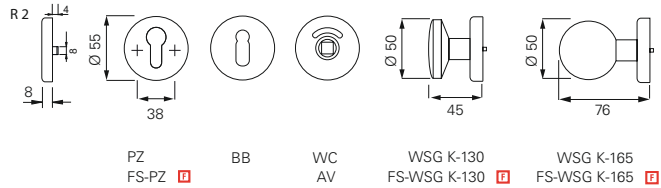

## OGG – HANDLE ON ROUND ROSE

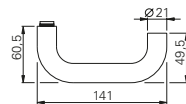

EN 1906 EN 179

= 4 7 - B1 1 4 0 U



			Fittings set						Passive leaf fittings set	
	Ø	▧								
	21 mm	8 mm		156505.46	156500.46	156510.46	156580.46	156520.46		
	21 mm	9 mm	356181.46	356100.46		356200.46	356270.46		356105.46	356318.46 356317.46
	21 mm	9 mm		356150.46						

Finish: matt brushed. PVD and polished on request

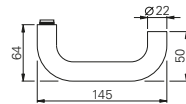

EN 1906 EN 179

= 4 7 - D1 1 4 0 U



			Fittings set						Passive leaf fittings set	
	Ø	▧								
	22 mm	8 mm		157505.30	157500.30	157510.30	157520.30			
	22 mm	9 mm	317230.30	357100.30		357200.30		357104.30	357318.30	357317.30
	22 mm	9 mm		357150.30						

Finish: F1 anodised aluminium; further colours available on request.

UGL – HANDLE ON ROUND ROSE

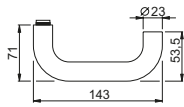

EN 1906 EN 179 F

F = 3 7 - D1 1 4 0 U



			Fittings set					Passive leaf fittings set	FS knob
	∅	▣							
S	23 mm	8 mm		154655	154650	154660	154670		
F	23 mm	9 mm	114300	354100		354200		354105	354317
	23 mm	9 mm		354150					

Material: PA nylon · Glossy finish

Note: Lever handle with continuous steel core. User category class 3 Compatible drilling template available, art. no.: 930317

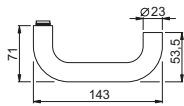

EN 1906 EN 179 F

F = 3 7 - D1 1 4 0 U



			Fittings set			Passive leaf fittings set
	∅	▣				
F	23 mm	9 mm	354600.02	354700.02	354604.02	354617.02

Material: PPN nylon, black

Note: Lever handle with continuous steel core. User category class 3 Compatible drilling template available, art. no.: 930317

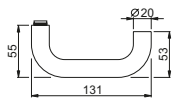

EN 1906

S = 3 7 - 0 1 4 0 U



			Fittings set		
	∅	▣			
S	20 mm	8 mm	150651	150660	150670

Material: Nylon · Glossy finish

Note: Nylon substructure with supporting cams. Lever handle with continuous steel core. Rose diameter: 52 mm.

Available with 7 mm or 8.5 mm square spindle on request. Lever handle with continuous steel core.

Compatible drilling template available, art. no.: 930317

Black
  Dark grey
  White
  Red
  Blue
 Further colours available on request.

# D-110 round rose

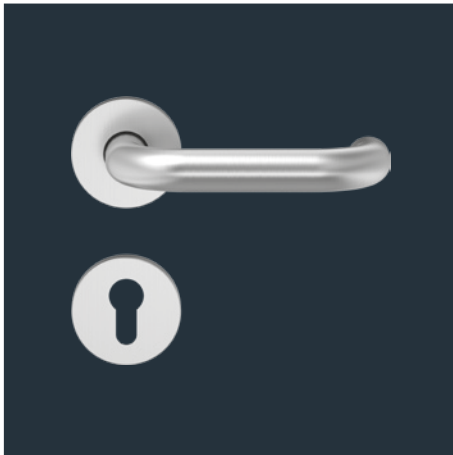

## D-110 round rose with SGL – friction bearing technology

Maintenance-free lever handle guidance integrated into the nylon base rose as a friction bearing. With spring assistance. Fixed swivel-mounted lever handles with ECO **CLICK** system for quick installation. Nylon substructure with supporting cams. Can be used for DIN left / DIN right. Concealed, continuous M5 screw attachment.

User category class 3. Supporting cams Ø 8 x 7 mm

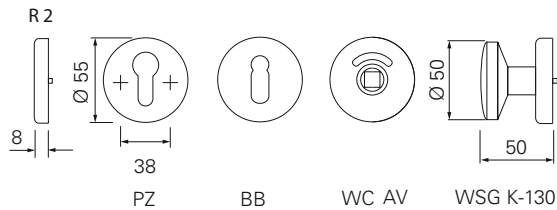



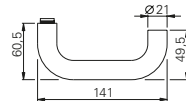

### SGL – HANDLE ON ROUND ROSE



EN 1906

**S** = 3 7 - 0 1 4 0 A



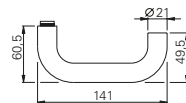

		Fittings set			
					
<b>S</b>	21 mm 8 mm	5030041324	5030041327	5030041336	5030041303

Finish: matt brushed. PVD and polished on request



EN 1906

**S** = 3 7 - 0 1 4 0 A

		Fittings set			
					
<b>S</b>	21 mm 8 mm	5030041333	5030041334	5030041342	5030041307

Finish: F1 anodised aluminium; further colours available on request.

# Product information and use of ECO fitting technology

## § 1 Product information and intended usage

1. The fitting systems made by ECO are assistive systems that can be used to help with opening and closing motions and/or locking processes for doors, glass doors and window elements.
2. The fixing elements supplied with these products must be used and installed according to the mounting instructions/specifications.

## § 2 Improper use of the products

Improper use of fitting systems for doors and windows (i.e. not using the product as intended) includes the following situations in particular:

- Installation or mounting of foreign objects and/or objects not intended for this purpose into the fitting system;
- Using auxiliary tools to operate the system;
- The fittings are used as a replacement for a missing wall buffer;
- Fittings are misused as a suspension device for heavy loads;
- Fittings are used long-term in combination with panic locks instead of only in emergencies, against the recommendation of the lock and fitting industry;
- Surface of the fitting systems damaged by the use of sharp or hard objects;
- The use of fasteners made by third-party manufacturers.

Sooner or later, these errors will cause damage, and the products will no longer have the characteristics defined by the manufacturer.

## § 3 Product performance

1. Product performance is only partially governed by standards. Many aspects of product performance have been developed based on years of experience and should be considered common knowledge in the construction hardware industry. Correspondingly, the contents of these standards and these empirical values should also be applied to fittings that are not expressly regulated.
2. Specifically, the following standards apply:
  - EN 1906: General benchmarks for door fittings and accessories;
  - DIN 18273: Special rules for fire and smoke control doors;
  - DIN 18257: Minimum security requirements for security fittings.
3. The fitting system must be replaced if, despite maintenance and servicing, it can no longer be ensured that it will function properly, and/or it may pose a risk of injury.
4. Furthermore, the products are continuously being improved, and manufacturing is subject to quality assurance. The right to make technical changes is reserved.

## § 4 Product maintenance

1. The user must ensure that the fitting systems and fixing elements are installed in a proper functional manner.
2. Depending on the material and where they are used, the products will face a certain degree of natural wear and tear. Consequently, all moving parts must undergo maintenance at least once per year; i.e. the proper fit, stability of the screw connections etc. must be checked on a regular basis. Only water, gentle cleaning agents and other cleaning agents that do not contain corrosive ingredients should be used for cleaning the fitting systems.
3. Manufacturing primarily uses the materials nylon, aluminium, stainless steel and brass. Please note that each of these different materials has different maintenance and servicing requirements.

## § 5 Duty to inform and instruct

1. The following documents are available to provide information and instruction:
  - Catalogues and brochures;
  - Tender documents;
  - Procurement information;
  - Bid documents;
  - Installation and operating instructions;
  - DIN standards.
2. In order to ensure that the fitting systems function properly:
  - Architects, planners and any other people involved in the process are required to request all the necessary product information from us and to comply with said information,
  - Specialised retailers are required to observe the product information and notes in the price lists and catalogues and, in particular, to request all required instructions from us and to pass them on to the processors,
  - The processors are required to obtain all product information and to comply with it, and, in particular, to request the operating and maintenance instructions from us and pass them on to the customers and users.

Overall, all parties involved must ensure that the fitting systems are properly assembled and installed and that each end user receives proper instructions and explanations.

# General information

## ECO Schulte recommends

For lever handle sets without a return spring, we recommend using locks that comply with DIN 18251 - class 3 or higher

In order to minimise the clearance between the lever handle set and the lock, we recommend locks that comply with DIN 18251 with a clamping nut.

When ECO handles are properly installed and used, the paint should withstand daily use. Excessive contact with hard or sharp objects (such as key rings, rings etc.) can scratch the surface. This does not impair functionality, however.

Our Compendium presents a compilation of all the products in our range. These are each subject to different supply classes. Special models are often configured to specific customer wishes and sometimes require longer lead-times and minimum order quantities. Your contact will be happy to advise you.



**ECO Schulte GmbH & Co. KG**

Iserlohner Landstraße 89

D-58706 Menden

Telephone +49 2373 9276 - 0

Telefax +49 2373 9276 - 40

[info@eco-schulte.de](mailto:info@eco-schulte.de)

[www.eco-schulte.de](http://www.eco-schulte.de)

Our compendium represents a compilation of all products from our range of services. These are subject to different delivery classes. Special variants included are often manufactured to customer specifications and sometimes require longer delivery times and minimum purchase quantities. Further advise can be given by your contact person.

## ■ SYSTEM TECHNOLOGY FOR THE DOOR

